

## Electromotoric actuator

SSA118.09HKN



**With KNX communication for radiator valves, PICV and small valves**

- Support of KNX S-Mode (integration with ETS)
- Direct mounting with coupling nut, no tools required
- Position and actuator motion indication (LED)
- Positioning force 100 N
- Parallel operation of multiple actuators possible
- Integral cable length 1.5 m

## Product and application description

The valve actuator SSA118.09HKN is suitable for installation on radiator or zone valves. It supports KNX S-Mode. It receives the setting commands via the KNX bus line from a room temperature controller (RTC).

The valve actuator with integrated bus coupling unit is connected via a bus connecting block to the KNX bus line. The power supply results from the bus voltage.

The valve adjustment works in proportion to an electromotive drive. Any valve position between two parametrizable limit values can be reached.

The device has two separate potential-free inputs, which can be used as a window contact or a presence contact.

The valve actuator provides a valve protection mode, activated if the set value has not been changed within 7 days. Thus, the valve completely opens and closes once to avoid valve seizing when not actuated over an extended period of time.

The valve actuator can be used directly after mounting on the valve and connecting to the bus voltage. If no application is loaded, the valve opens 25% automatically after automatic calibration.

## Application program in S-Mode

- Automatic adjustment, different operating modes selectable
- Valve protection mode
- Forced mode
- Maximum actuating value limitation (min./max.)
- Adaption to valve characteristics
- Monitoring of current position
- Determination and forwarding of the maximum actuating value
- Transmission of the current position
- Potential-free input for window contact
- Potential-free input for condensation/presence contact
- Summer mode



---

Application programs in S-Mode are described in detail in doc A6V12066162. See Product documentation [→ 6] for more information.

---

## Use

- For radiator valves, VDN.., VEN.., VUN..
- For Siemens PICV (pressure independent combi valves) VPP46.. and VPI46..
- For MiniCombi valves VPD.., VPE..
- For small valves VD1..CLC
- For radiator valves (M30 × 1.5) from other manufacturers without adapter
- Typically used on radiator or zone valves.

**Overview**

	1	Protective cover for manual operation. Use a screwdriver to open before manually adjusting the actuator stem position.
	2	Enable/disable button of manual operation
	3	Hand adjustment with hex key for manual operation
	4	KNX programming button
	5	Stem position LED indicator
	6	KNX programming LED

**Enable/disable button of manual operation**

Activity	Button operation	Confirmation
Enter/exit local override mode	Press button > 3 s. See Manual operation [→ 9] for details.	The actuator stem position indicator flashes green and red.

**Manual operation button**

Activity	Button operation	Confirmation
Move actuator stem up or down	Rotate button clockwise or anti-clockwise using a hex key. See Manual operation [→ 9] for details.	The stem position indicator flashes green. When a set position is reached, the LED is lit constantly for five seconds and then turns off.

**KNX programming button**

Activity	KNX programming button operation	Confirmation
Enter/exit addressing mode	Press button < 2 s	KNX programming LED turns red or off
Reset to factory settings	Press button > 20 s	KNX programming LED flashes yellow until device restarts

### Protection against unintended KNX programming button pressure

The actuator provides a mechanical function to prevent accidental pressure of the KNX programming button.

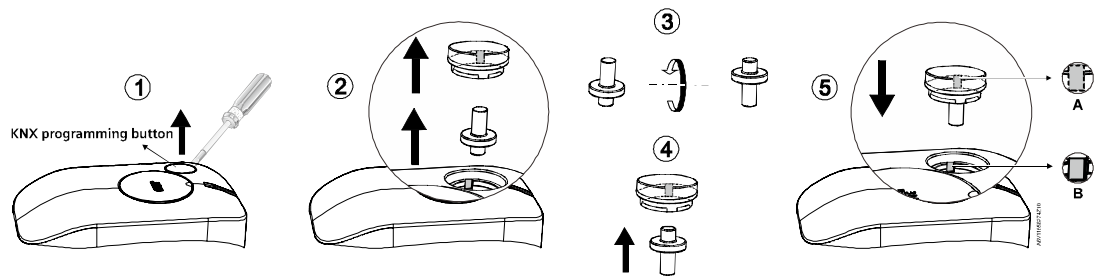

<b>!</b>	<b>NOTICE</b>
	Fully align A and B illustrated in Step 5 when reassembling the actuator.

### Addressing and bus test with the KNX programming button

Press the KNX programming button (< 2 s) to set the actuator to addressing/programming mode:

- KNX bus wiring OK → LED turns red until addressing/programming is finished.
- KNX bus wiring not OK → LED stays off.

### Reset using the KNX programming button (master reset)

Reset the actuator by pressing the KNX programming button for more than 20 s. The LED flashes yellow and the device restarts. All parameters are then reset.

## LED colors and patterns

### Stem position indicator

Color	Pattern	Flashing interval	Description
Green	Flashing	0.1 s	Self-calibration
		0.5 s	Actuator stem is moving.
	Constant	-	Actuator stem reaches a set position. The LED turns off after it is constantly on for five seconds.
Green/red	Flashing	0.5 s	Manual operation
Red	Constant	-	Error*

\* Hint: calibration or power reset required.

## KNX programming LED

Color	Pattern	Flashing interval	Description
Green	Constant	-	Connection test successful
Yellow	Flashing	0.1 s	Factory reset in progress
		1.75 s	After connection test: wait
Red	Constant	-	Device is in programming/addressing mode
	Flashing	2 s	Internal error: Power reset necessary
		1 s	After connection test: Connection test failed

## Type summary

Type	Stock number	Operating voltage	Running speed	Running time 2.5 mm	Control signal	Cable length
SSA118.09HKN	S55180-A111	Via KNX bus line	20 s/mm	50 s	KNX-TP	1.5 m

## Ordering

When ordering, specify both type and quantity.

Example:

Type	Stock number	Designation	Quantity
SSA118.09HKN	S55180-A111	Electromotoric actuator KNX	2

## Delivery

This type contains only the electromotoric actuator. Valves have to be ordered separately. The position of the actuator stem (spindle) is fully retracted for easier valve assembly.

## Equipment combinations

### Valves

Type reference	Valve type	K <sub>vs</sub> [m <sup>3</sup> /h]	$\dot{V}$ [l/h]	PN class	Data sheet
VDN.., VEN.., VUN..	Radiator valves	0.09...1.41	-	PN 10	N2105, N2106
VPD.., VPE..	MCV radiator valves	-	25...483*		N2185
VD1..CLC	Small valves	0.25...2.60	-		N2103
VPP46.., VPI46..	PICV valves DN10..DN32	-	30...4001	PN 25	N4855
K <sub>vs</sub> : Nominal flow rate of cold water (5...30 °C) through the fully open valve (H100) by a differential pressure of 100 kPa (1 bar).					
<i>Radiator valves (M30 × 1.5) from other manufacturers, without adapter:</i>					
• Heimeier		• Crane D981..		• TA-Type TBV-C	
• Oventrop M30 × 1.5 (from 2001)		• MNG		• Junkers	
• Honeywell-Braukmann		• Cazzaniga		• Beulco (new)	

\* Nominal volume flow at 0.5 mm stroke.

**Note:** To ensure trouble-free operation of third-party valves with the SSA.. actuator, the valves must satisfy the following requirements:

- Threaded connections with coupling nut M30 × 1.5.  
(Alternatively the valve actuator can be combined with suitable adapter rings, which are available at a HVAC dealer.)
- Nominal force  $F \leq 100 \text{ N}$
- Dimension  $X > 8.3 \text{ mm}$
- Dimension  $Y \leq 14.8 \text{ mm}$

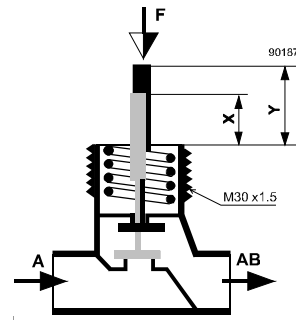

## Room thermostats

Type	Details
RDG..	RDG100KN, RDG160KN, RDG165KN

## Product documentation

Topic	Title	Document ID:
Mounting and installation	Mounting instructions <sup>1)</sup>	A6V11858274
Standards and directives	CE declarations	A5W00106106A
	RCM conformity	A5W00106107A
Environmental compatibility	Environmental declarations	A5W00109220A
KNX S-Mode programming	Application program description	A6V12066162

<sup>1)</sup> Mounting instructions enclosed with product packaging.

Related documents such as environmental declarations, CE declarations etc., can be downloaded from <http://siemens.com/bt/download>.

Technical documentation and ETS application can be downloaded at <http://www.siemens.com/gamma-td> (S-Mode).



To search for the technical documentation, you can enter the product type in <http://www.siemens.com/gamma-td>, or enter either the product type or the document ID in <http://siemens.com/bt/download>.

## Notes

### Engineering

The actuators must be electrically connected in accordance with local regulations (see "Connection diagram [→ 12]").



#### **CAUTION**

#### **National safety regulations**

Failure to comply with national safety regulations may result in personal injury and property damage.

- Observe national provisions and comply with the appropriate safety regulations.

Observe permissible temperatures (see "Technical data [-> 11]"). The connecting cable of the actuator may come in contact with the hot valve body, provided the temperature of the valve body does not exceed 80 °C.

## Mounting

	<p><b>⚠ WARNING</b></p>
	<ul style="list-style-type: none"> <li>Do not use pipe wrenches, spanners or similar tools.</li> <li>Before mounting, fit the actuator in a position where the actuator stem is fully retracted (see "Manual operation [-&gt; 9]").</li> <li>Avoid lateral pressure or (cable) tension on the mounted actuator!</li> </ul>

Valve and actuator are easy to assemble on site before commissioning:

- Remove protective cover from the valve body.
- Position the actuator and tighten the coupling nut manually.
- Mount the actuator on the valve before download of the application.
- If re-mounting to another valve is necessary, dismantle the actuator from the current valve by rotating the actuator stem anti-clockwise.
- See [Mounting instructions](#) enclosed with the product package for graphical instructions.

### Orientation

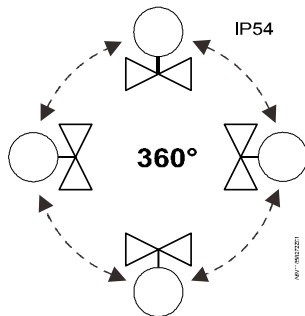

## Installation

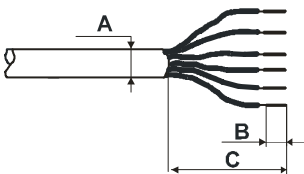
	A [mm]	B [mm]	C [mm]
	4.35	4.2	70
Crimp ferrule on stripped wire of connecting cable.			

- Observe all admissible temperatures (see "Technical data [-> 11]").
- Operate the actuator only with alternating current (see "Technical data [-> 11]").
- Do not twist the cable.
- Magnets can damage the actuator.

	<p><b>⚠ CAUTION</b></p>
	<p><b>National safety regulations</b></p> <p>Failure to comply with national safety regulations may result in personal injury and property damage.</p> <ul style="list-style-type: none"> <li>Observe national provisions and comply with the appropriate safety regulations.</li> </ul>



**⚠ CAUTION**

Regulations and requirements to ensure the safety of people and property must be observed at all times!

### Commissioning

When commissioning, check both wiring and functioning of the actuator.

- Actuator stem extends                      Valve closes
- Actuator stem retracts                      Valve opens



**NOTICE**

Commission the actuator only with a valve mounted correctly in place!

### Self-calibration

The actuator self-calibrates (fully retracted → fully extended → setpoint) after initial connection of bus voltage, after every download of the application, and after bus voltage recovery.

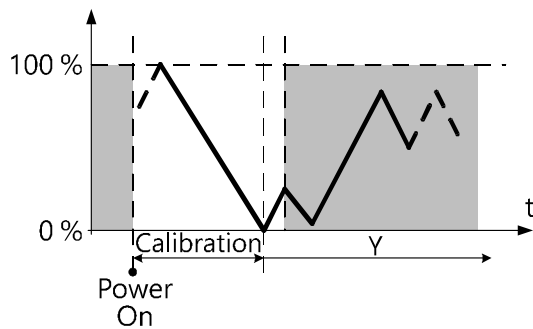

During calibration, the valve is measured and the positions for “valve open” and “valve closed” are stored. In S-Mode, it is possible to only calculate the “valve open” position by working back from a set path from the closed position (to close the valve, the actuator stem extends until the set force is exerted on the valve).

After every download of the application, calibration takes place and the values determined are compared. If the values do not match, calibration is repeated twice until two consecutive value pairs match. These values are then stored and the positions used afterwards.

Recalibration occurs at regular intervals (180 days) and after reset.



**⚠ CAUTION**

Never intervene manually during self-calibration.



<b>!</b>	<p><b>NOTICE</b></p> <ul style="list-style-type: none"> <li>• Correct calibration is only possible with valve stroke &gt; 1.2 mm. Valve stroke &lt; 1.2 mm results in calibration failure.</li> <li>• If calibration fails, the actuator performs another calibration automatically after 10 seconds.</li> <li>• After three failed calibration attempts, the actuator stem remains in the extended position.</li> </ul>
----------	--

## Manual operation

Use a 3-mm hexagonal socket wrench to move the actuator to a different position.

### To move the actuator stem manually

1. Open the cover using a proper screwdriver. Note that IP54 protection does not apply if the cover is open.
2. Press and hold down the enable/disable button of manual operation for at least three seconds.
  - ⇒ The actuator ignores any control signal from the controller.
3. Adjust the actuator stem position by rotating the manual operation button clockwise or anti-clockwise.
  - ⇒ The actuator stem moves down if you rotate clockwise; it moves up if you rotate anti-clockwise. The manually set position is retained.
4. If you want to exit the manual operation mode, press and hold down the enable/disable button of manual operation for at least three seconds.
  - ⇒ The actuator self-calibrates automatically. A control signal sent from the controller takes effect.
5. Close the cover to ensure IP54 protection.

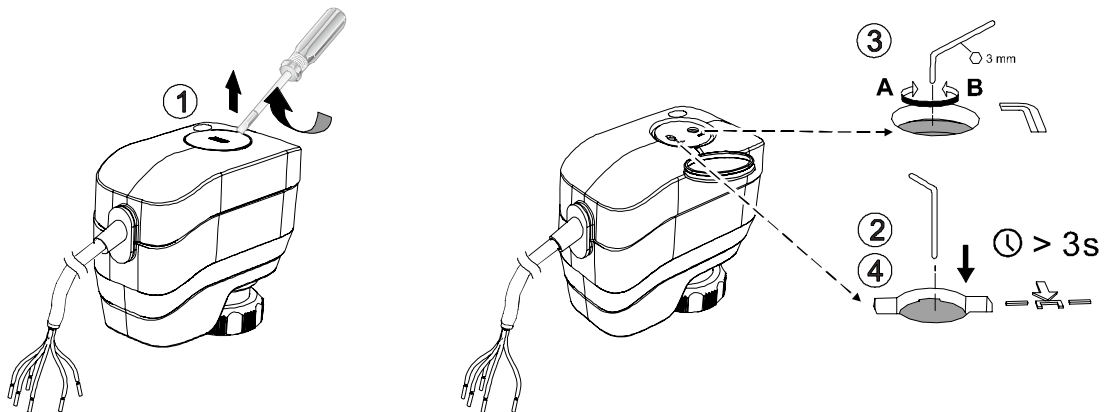

<b>!</b>	<p><b>WARNING</b></p> <p>If operating voltage is switched on, press the enable/disable button of manual operation before and after adjusting the position of the actuator stem. If you switched off both operating voltage and control signal, you can adjust the position directly without pressing the button.</p>
----------	--

## Maintenance

The actuators require no maintenance.



**⚠ WARNING**

Operating voltage must be switched off during any maintenance!



**NOTICE**

When carrying out service work on the plant, note the following:

- Switch off operating voltage.
- If necessary, disconnect electrical connections from the terminals.
- Commission the actuator only with a correctly-mounted valve!

**Repair**

The actuators cannot be repaired; replace the entire unit.

**Disposal**

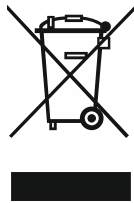

The device is considered an electronic device for disposal in accordance with the European Guidelines and may not be disposed of as domestic garbage.

- Dispose of the device through channels provided for this purpose.
- Comply with all local and currently applicable laws and regulations.

**Open Source Software (OSS)**

**Software license overview**

These devices use Open Source Software (OSS). All Open Source Software components used in the product (to include copyrights and licensing agreement) are available at <http://siemens.com/bt/download>.

Firmware version	OSS document		Device
	Document ID	Title	
1.1.28	A6V12067581	Readme OSS "MRA KNX – 1.1"	SSA118.09HKN

## Technical data

Power supply		
KNX bus voltage	DC 24 V (DC 21...30 V)	
KNX bus current	Running	Max. 15 mA
	Holding	5 mA
KNX power loss (internal consumption)	Approx. 0.36 W	

Signal input	
Control signal	Via KNX bus

Operating data	
Positioning speed	20 s/mm ± 25 %
Positioning force	100 N
Stroke	1.2...6.5 mm
Permissible temperature of medium in the connected valve	1...110 °C (1...90 °C for MCV-radiator valves)

Electrical connection (connecting cable integral)	
Cable length	1.5 m, as per VDE 0207
Cross section of pre-wired connection cables	6 × 0.324 mm <sup>2</sup>
Permissible length for signal lines	350 m (if standardized TP1 cables are used)

Mounting	
Fixing on valve	Plastic coupling nut M30 × 1.5
Orientation	360°

Standards	
EU conformity (CE)	A5W00106106A*
RCM conformity	A5W00106107A*
Environmental compatibility	The product environmental declaration (A5W00109220A*) contains data on environmentally compatible product design and assessments (RoHS compliance, materials composition, packaging, environmental benefit, disposal).

\* The documents can be downloaded from <http://siemens.com/bt/download>.

Protection settings	
Pollution degree rating as per EN 60730-1	2
Overvoltage category as per EN 60730-1	III
Housing protection degree	IP 54
Protection class as per EN 60730	II
Electrical safety, bus	Safe extra low voltage SELV DC 29 V
Electrical safety, device complies with	EN 60730-1
EMC requirements, device complies with	EN 50491-5-1, EN 50491-5-2, EN 50491-5-3

Reliability	
Failure rate (at 20 °C)	1141 fit

General ambient conditions			
	Operation EN 60721-3-3	Transport EN 60721-3-2	Storage EN 60721-3-1
Environmental conditions	Class 3K3	Class 2K3	Class 1K3
Temperature	1...50 °C	-25...70 °C	-5...50 °C
Humidity	5...85 % r.h.	< 95 % r.h.	5...95 % r.h.

Material	
Cover/base	PC + ABS
Fire load	Approx. 5 MJ

Weight	
SSA118.09HKN	240 g

## Diagrams

### Connection terminal

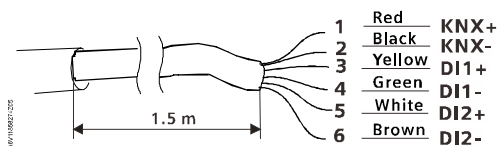

- KNX bus line: Bus coupling unit (red +/black -). The connecting cable can be extended to max. 350 m, if a standardized TP1 cable is used.
- DI1 is used for window contacts (yellow/green). The window contacts have to be connected directly without additional supply voltage.
- DI2 (white/brown) is used for potential-free input for e.g. presence detectors and condensation contacts.



### NOTICE

DI1 and DI2 can be connected to any Open/Close contact (window contact, condensation contact, presence detector, etc.). We recommend connecting DI1 to a window contact and DI2 to a presence detector or condensation contact.

### Connection diagram

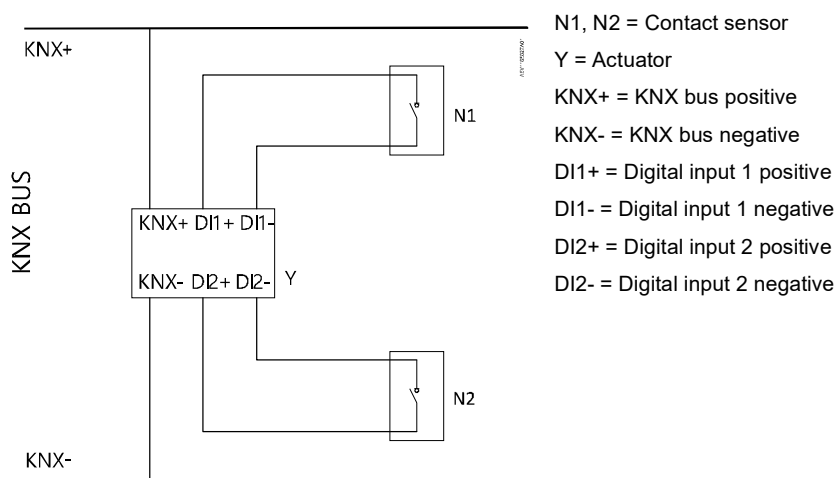

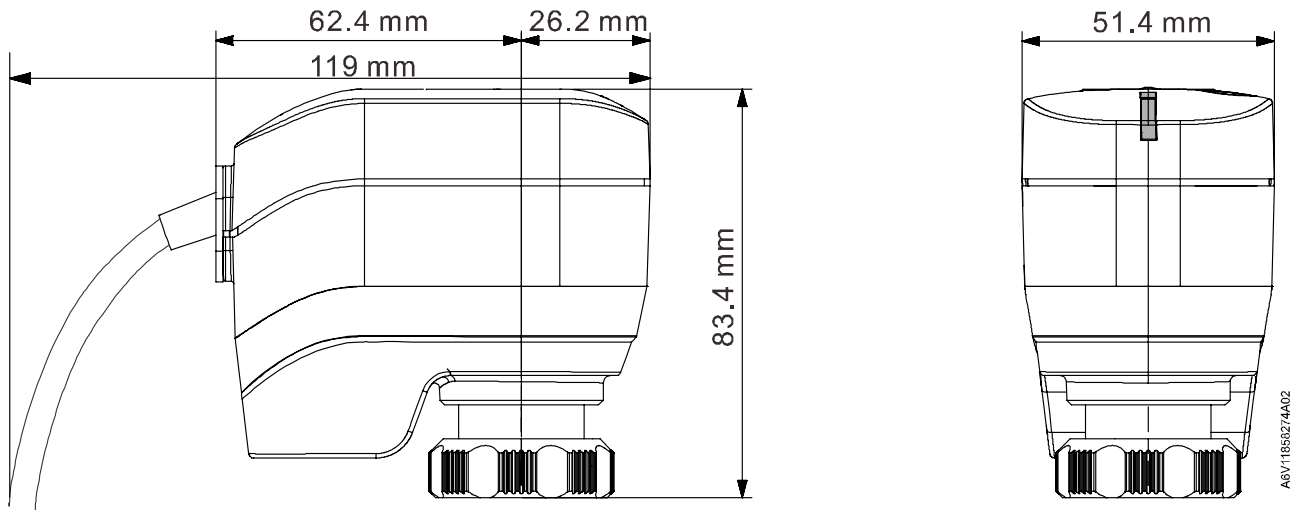

## Dimensions



## Revision numbers

Type	Valid from rev. no.
SSA118.09HKN	..A

## Support

- Hand over the operating instructions and all other technical product information to the client.
- Return faulty devices with a return delivery note to the local Siemens office.
- For technical questions, contact:
  -  +49 (911) 895-7222
  -  +49 (911) 895-7223
  -  support.automation@siemens.com
  - <http://www.siemens.com/supportrequest>



Technical Support:

<http://www.siemens.com/supportrequest>



FAQ:

<https://support.industry.siemens.com/cs/ww/en/ps/faq>