

Pioneering for You

*HVAC OEM Competence Centre*

# Yonos PARA RS \*\*/6 RKA Datasheet



**ErP**  
READY

APPLIES TO  
EUROPEAN  
DIRECTIVE  
FOR ENERGY  
RELATED  
PRODUCTS

# Yonos PARA RS \*\*/6 RKA



Field of application



Heating

Yonos PARA RS 15/6 RKA 130 12

**Yonos PARA**

**High Efficiency pump for heating application**

RS	Inline cast iron pump housing
15	Threaded connection DN 15 (25, 30: also available )
6	6 = delivery head in [m] at Q = 0 m <sup>3</sup> /h
RKA	The pump is controlled by Red Knob technology RKA = $\Delta P-v$ , $\Delta P-c$
130	Pump housing length 130 mm (180 mm: also available)
12	Control box orientation 12 o'clock (3, 6, 9 o'clock: also available)

# Hydraulic operational area $\Delta p-v$ (variable)

## $\Delta p-v$ (variable)

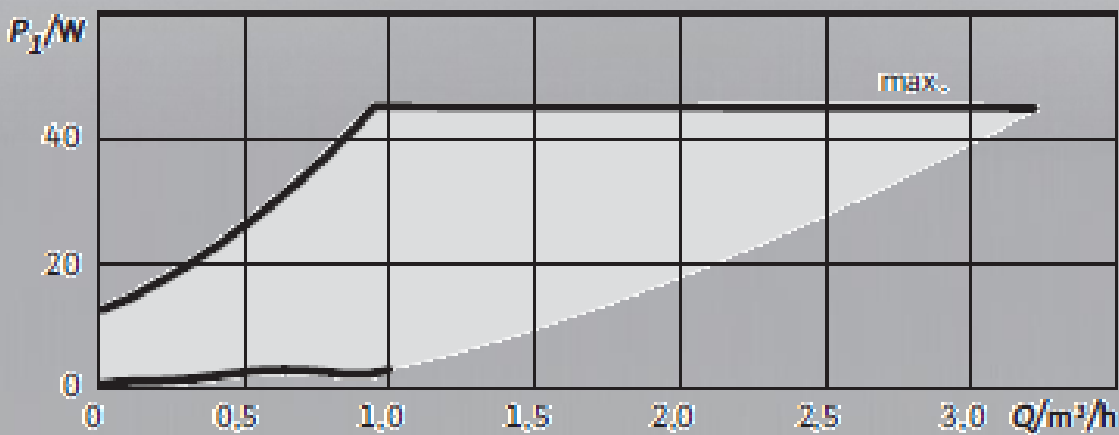
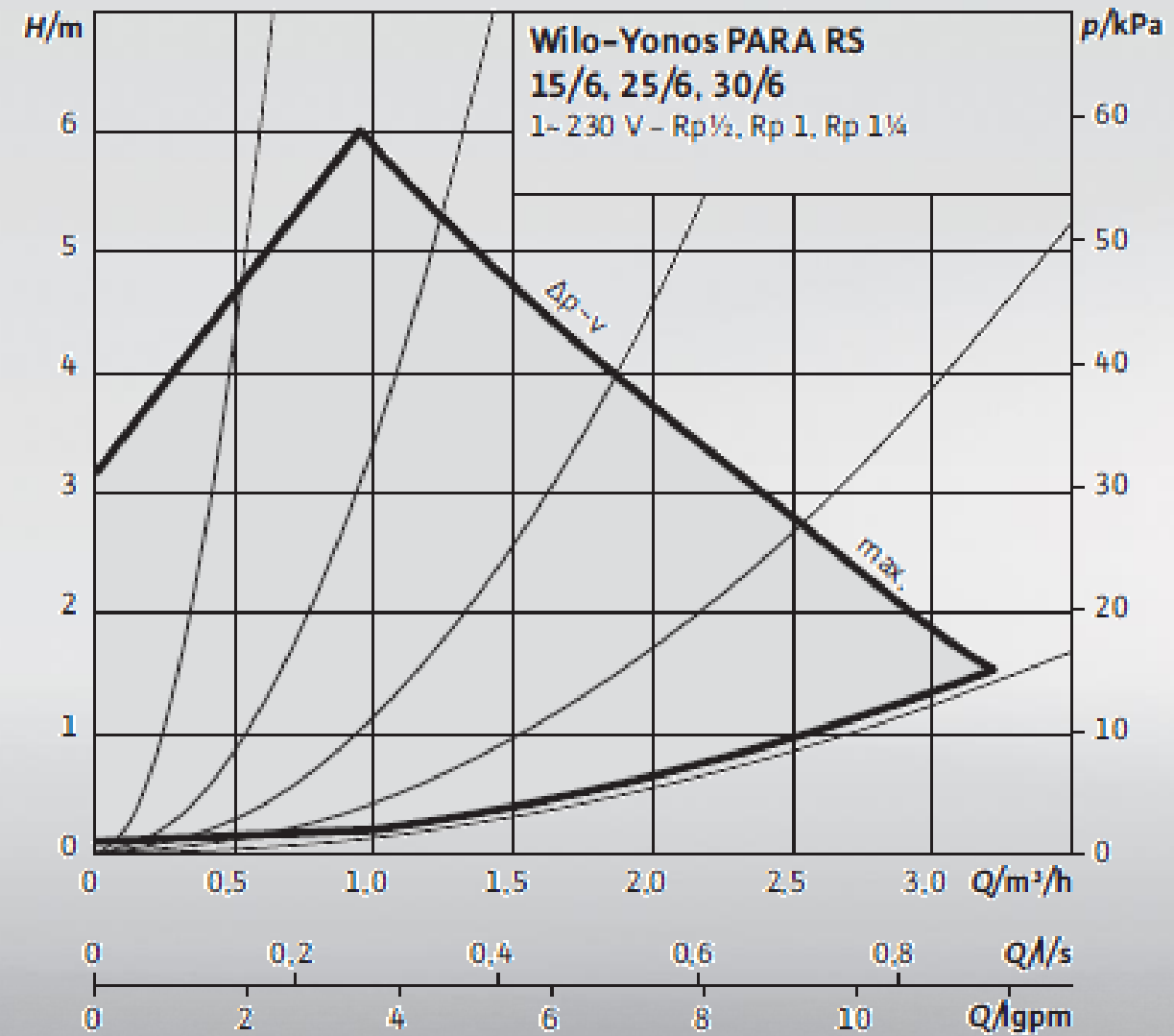

# Hydraulic operational area $\Delta p$ -c (constant)

## $\Delta p$ -c (constant)

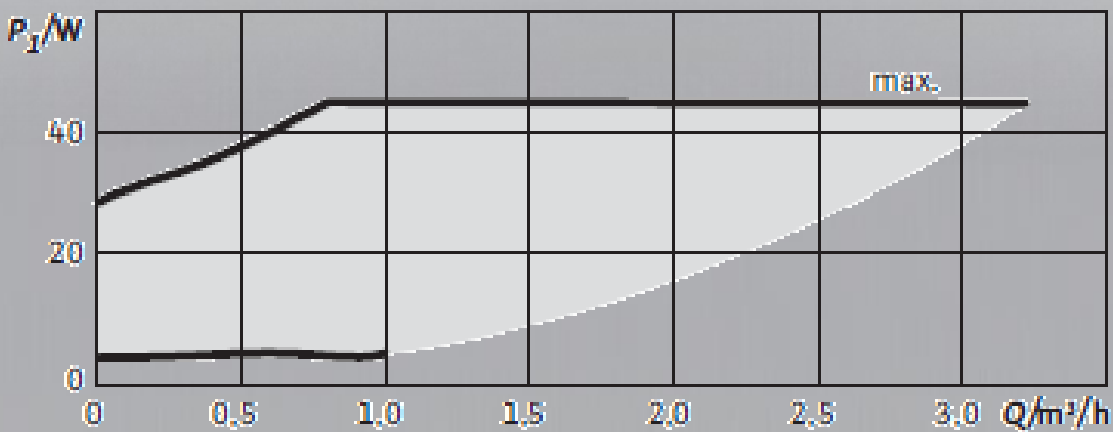
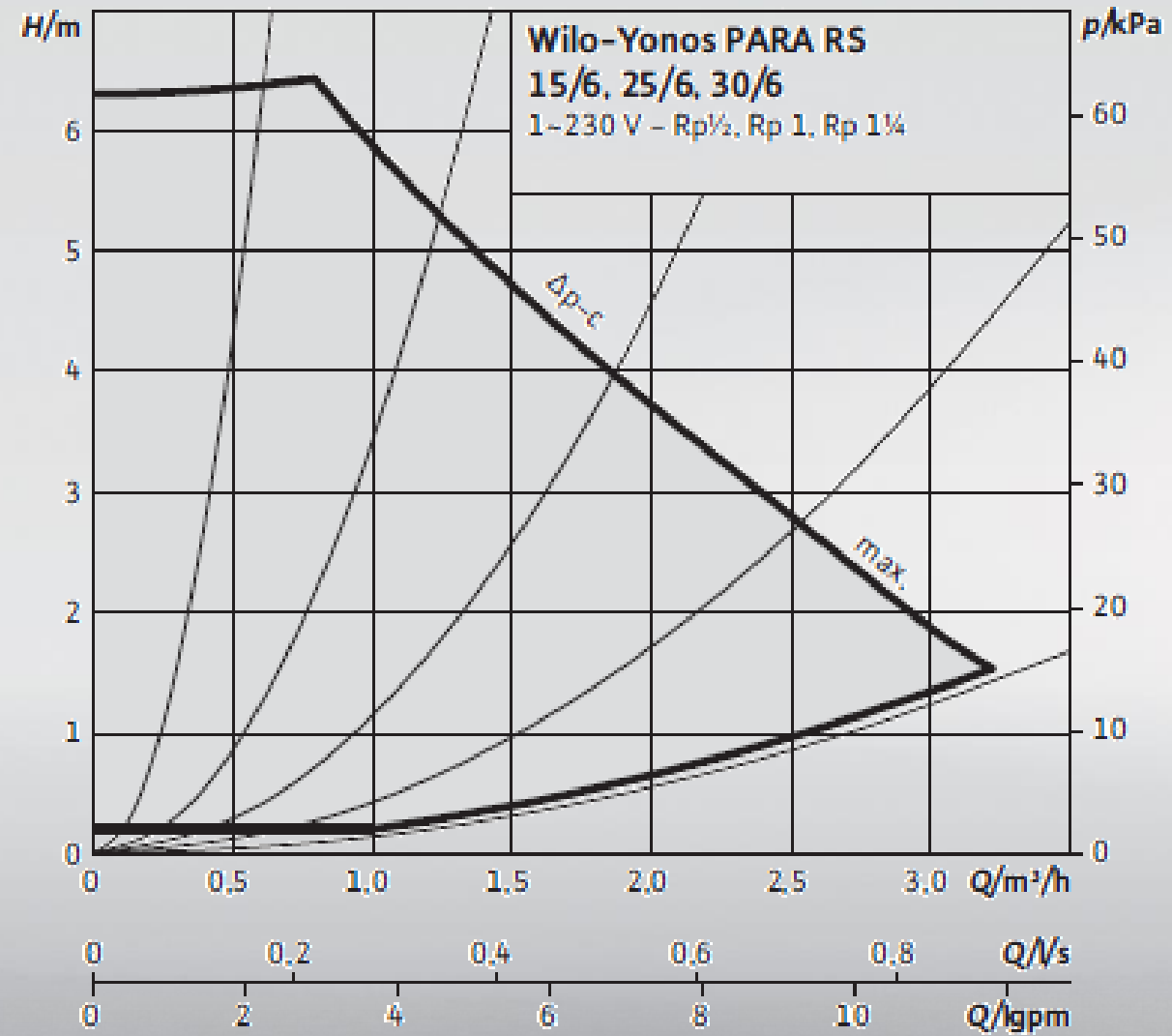

# Electrical connections



Integrated Molex 3-way connector



Overmoulded connector

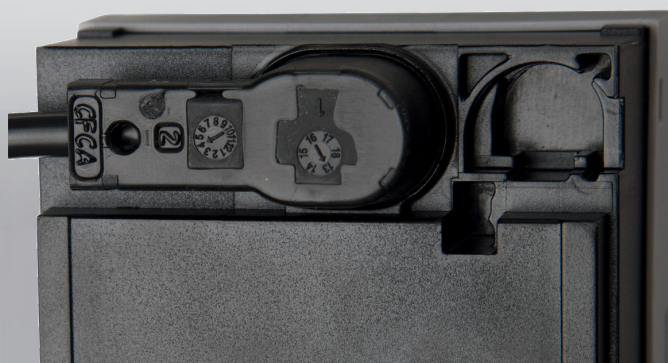

Overmoulded power cables

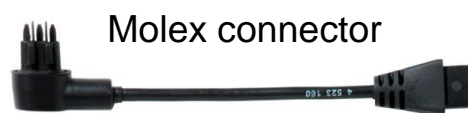
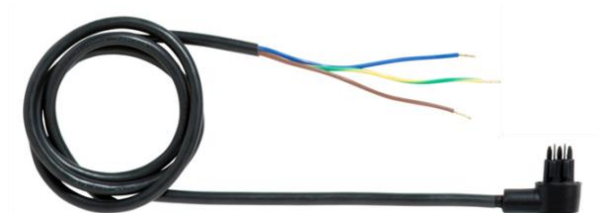

Volex connector

WS8 connector

## Dimensions

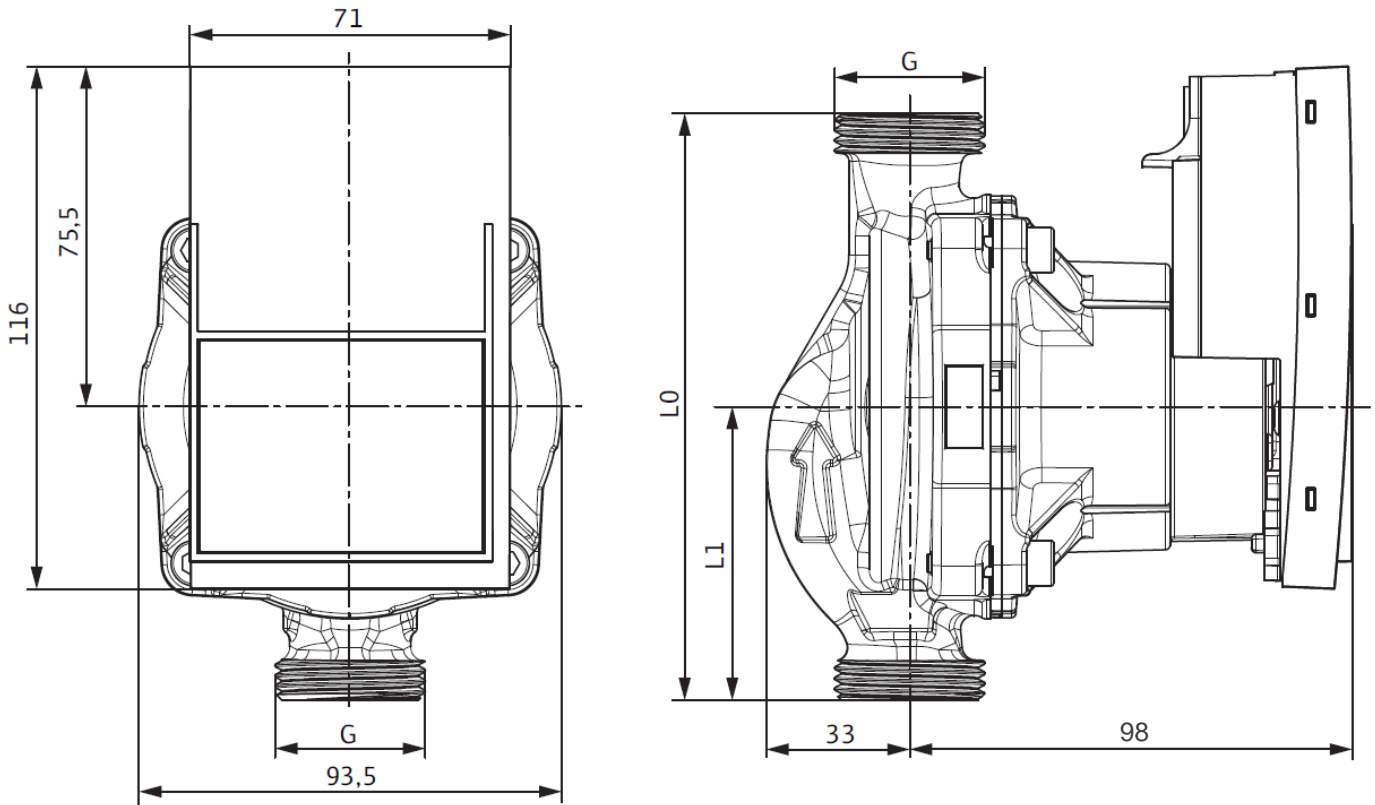

Thread	Overall length (mm)	Dimensions (mm)
	10	L1
G1"	130	65
G1"½	130	65
G1"½	180	90
G2"	180	90

Approved fluids (other fluids on request)	Heating water (in accordance with VDI 2035) Water-glycol mixtures (max. 1:1; above 20% admixture, the pumping data must be checked)
--	--

**Power**

Energy Efficiency Index (EEI)	≤ 0,20
Max. delivery head	6.2 m
Max. volume flow	3.3 m³/h

**Permitted field of application**

Temperature range for applications in HVAC systems at max. ambient temperature. Limit values for continuous operation at maximum rated power	Of 58°C = 0 to 100°C Of 62°C = 0 to 90°C Of 66°C = 0 to 80°C Of 71°C = 0 to 70°C
Maximum static pressure	PN 6

**Electrical connection**

Mains connection	1~230 V +10%/-15%, 50/60 Hz (IEC 60038 standard voltage)
------------------	--

**Motor/electronics**

Low voltage directive	2006/95/EC Conform
Electromagnetic compatibility	EN 61800-3
Emitted interference	EN 61000-6-3 EN 61000-6-4
Interference resistance	EN 61000-6-2 EN 61000-6-1
Protection class	IPx4D
Insulation class	F
RoHS / REACH	Not submitted

**Minimum suction head at suction port to avoid cavitation at water pumping temperature**

Minimum suction head at 50/95°C	0.5/4.5 m
---------------------------------	-----------

**Motor data**

Yonos PARA	Speed	Power consumption 1-230 V	Current at 1-230 V	Motor protection
	n	P1	I	-
	rpm	W	A	-
RS **/6 RKA	800 - 4300	3-45	0.03-0.44	Integrated

**Materials**

Yonos PARA	Pump housing	Impeller	Pump shaft	Bearing
RS **/6 RKA	Cast iron with cataphoresis treatment	PP composite with GF 40%	Stainless steel	Carbon, metal impregnated



# wilo

**WILO**  
HVAC OEM Competence Centre

50 av. Casella  
18700 - Aubigny sur Nère  
France  
T +33 2 48 81 62 62  
[information@wilointec.com](mailto:information@wilointec.com)  
[www.wilo-oem.com](http://www.wilo-oem.com)

Pioneering for You